

RADIUS and FreeRADIUS

Frank Kuse

Presented at AfNOG 2016



Ingredients

- ◆ Theory
 - ◆ What is RADIUS
 - ◆ Why use RADIUS
 - ◆ How RADIUS works
 - ◆ User databases
 - ◆ Attributes
- ◆ Practical
 - ◆ Installing FreeRADIUS
 - ◆ Configuration of Radius with LDAP Database backend
 - ◆ Testing Radius Authentication with LDAP user account



What is RADIUS?

- ◆ Remote Authentication Dial In User Service
- ◆ Authentication
 - ◆ “Who are you?”
- ◆ Authorization
 - ◆ “What services am I allowed to give you?”
- ◆ Accounting
 - ◆ “What did you do with my services while you were using them?., Accounting information may be used to track the user's usage for charging purposes

Why RADIUS?

- ◆ What are the alternatives?
 - ◆ LDAP, Kerberos, Active Directory
- ◆ Advantages of RADIUS:
 - ◆ Lightweight and efficient
 - ◆ Supported by many clients, e.g. 802.1x, switches and routers
- ◆ Disadvantages of RADIUS:
 - ◆ Limited attribute set, limited use for desktop authentication

How does RADIUS work?

- ◆ Authentication
 - ◆ Password authentication, plain text and hashed
 - ◆ Lookup in various user databases: passwd, SQL, text
- ◆ Authorization
 - ◆ Using a set of rules or other templates
- ◆ Accounting
 - ◆ Measuring, communicating and recording resources accessed by user
- ◆ See Wikipedia for list of RFCs

RADIUS Architecture (1)

- ◆ RADIUS protocol is between NAS(Network Access Server) or a RAS(Remote Access server) and AAA server
- ◆ NAS controls access to protected resource

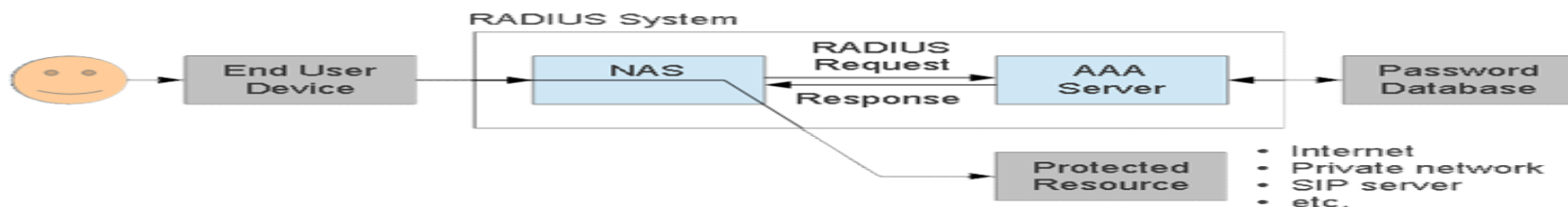

RADIUS Architecture (2)

Scenario 1

In this scenario, a front-end NAS (network access server) or RAS (remote access server) performs authentication of a user with a backend RADIUS server.

The NAS/RAS sends user information (credentials) to the RADIUS server carried in RADIUS packets. The RADIUS server implements the access policy (who is granted access with what authorizations) or may retrieve policies from a database through LDAP (Lightweight Directory Access Protocol).

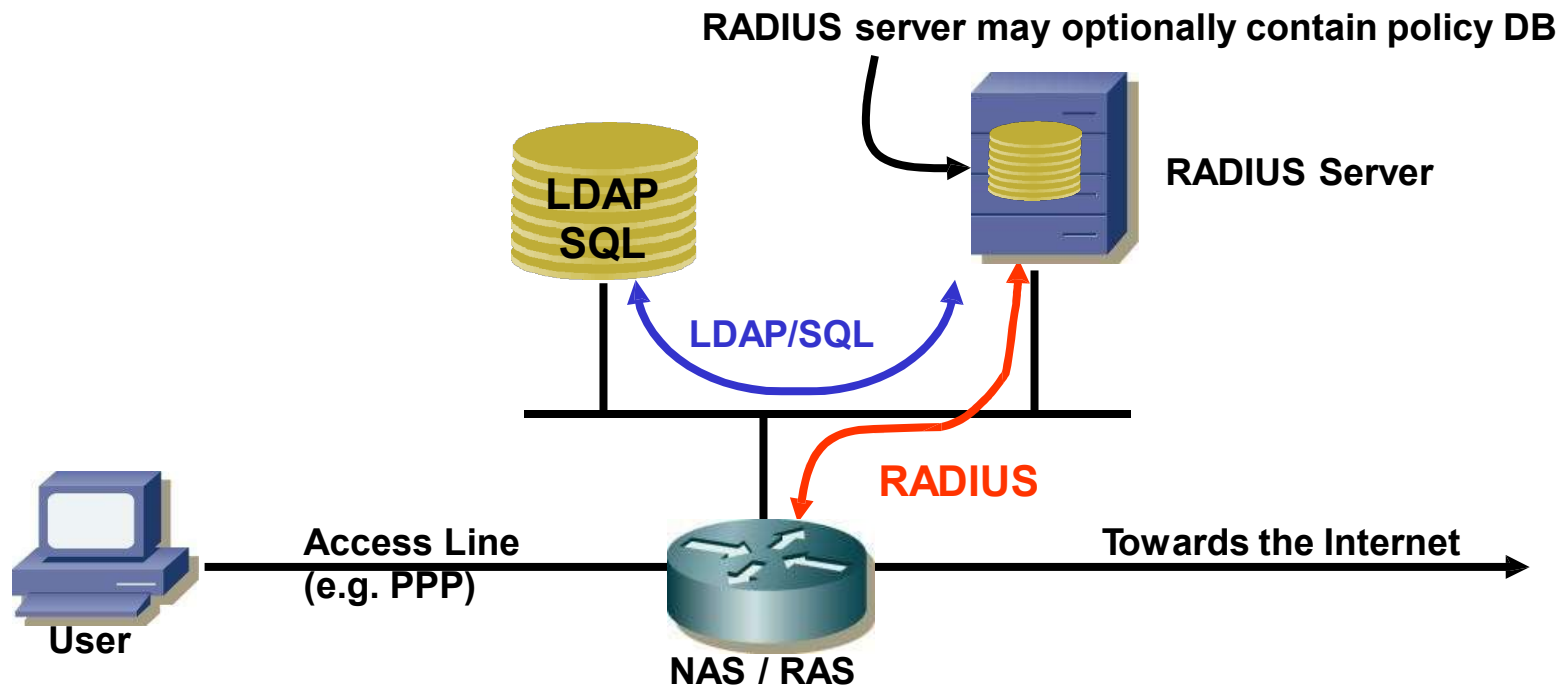

RADIUS Architecture (3)

Scenario 2

In this scenario, a first RADIUS server does not perform authentication but acts as a proxy that routes RADIUS requests to the appropriate home RADIUS server. The routing is based on username and realm.

The home RADIUS server performs the actual authentication by accessing a user DB.

A concurrency RADIUS server may be employed to make sure that a user is not logged in more than once, e.g. in scenarios with multiple RADIUS servers for redundancy / load balancing.

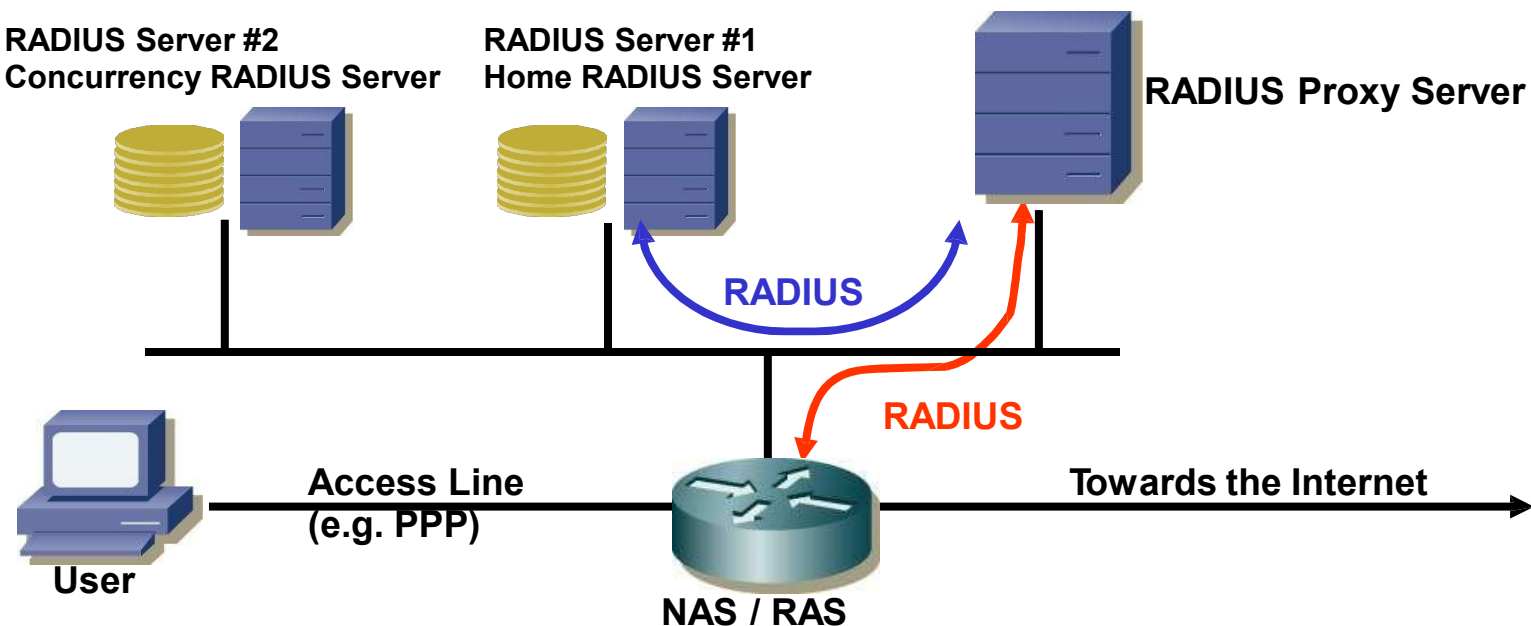

RADIUS Authentication

RADIUS transaction

A RADIUS transaction typically starts with an Access-Request carrying user credentials followed by a RADIUS server response with a grant or denial of access.

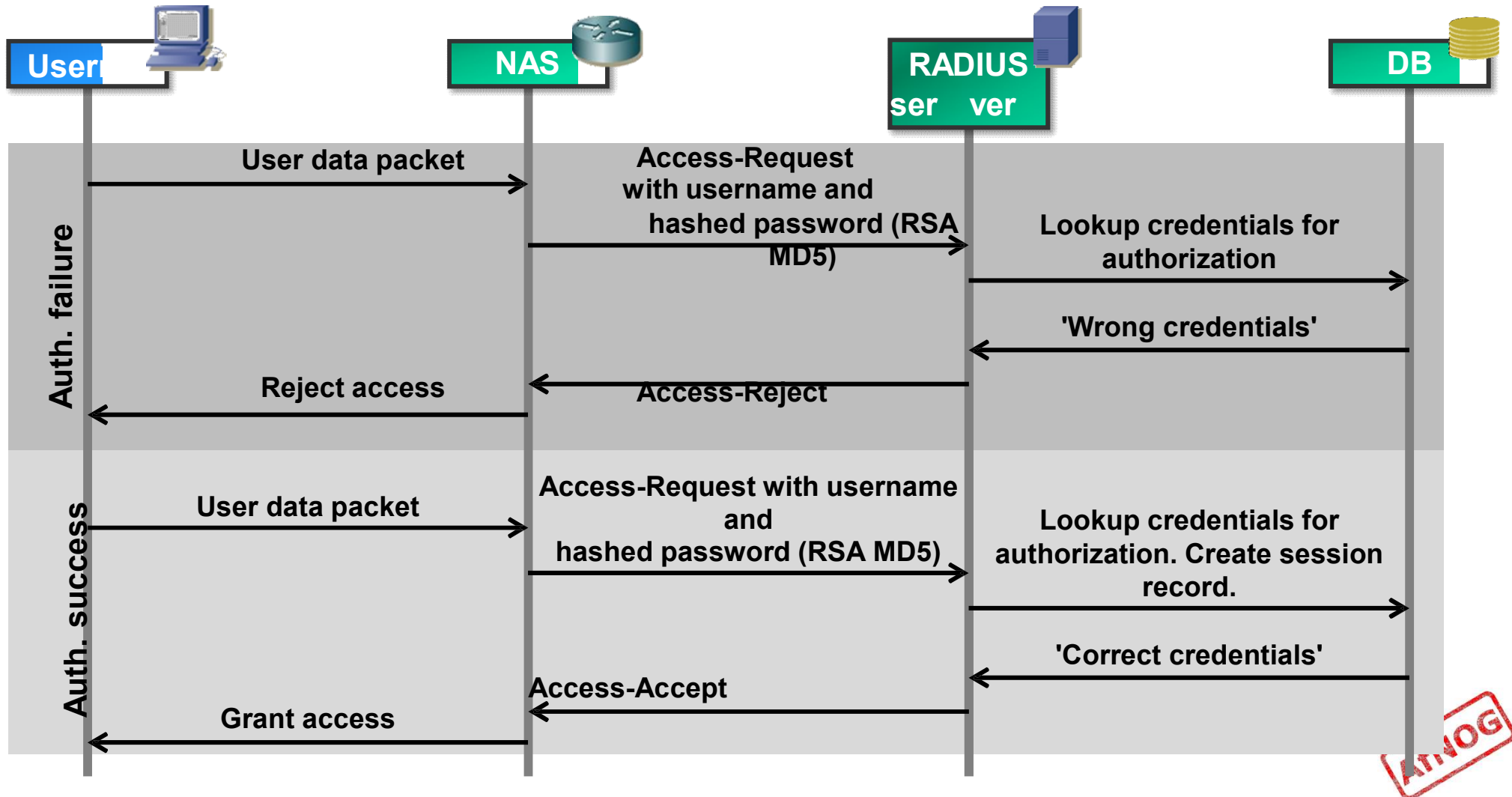

RADIUS Accounting (1)

RADIUS accounting

Once a network session is up and running (successful authentication), the NAS may request to start counting network usage of the user.

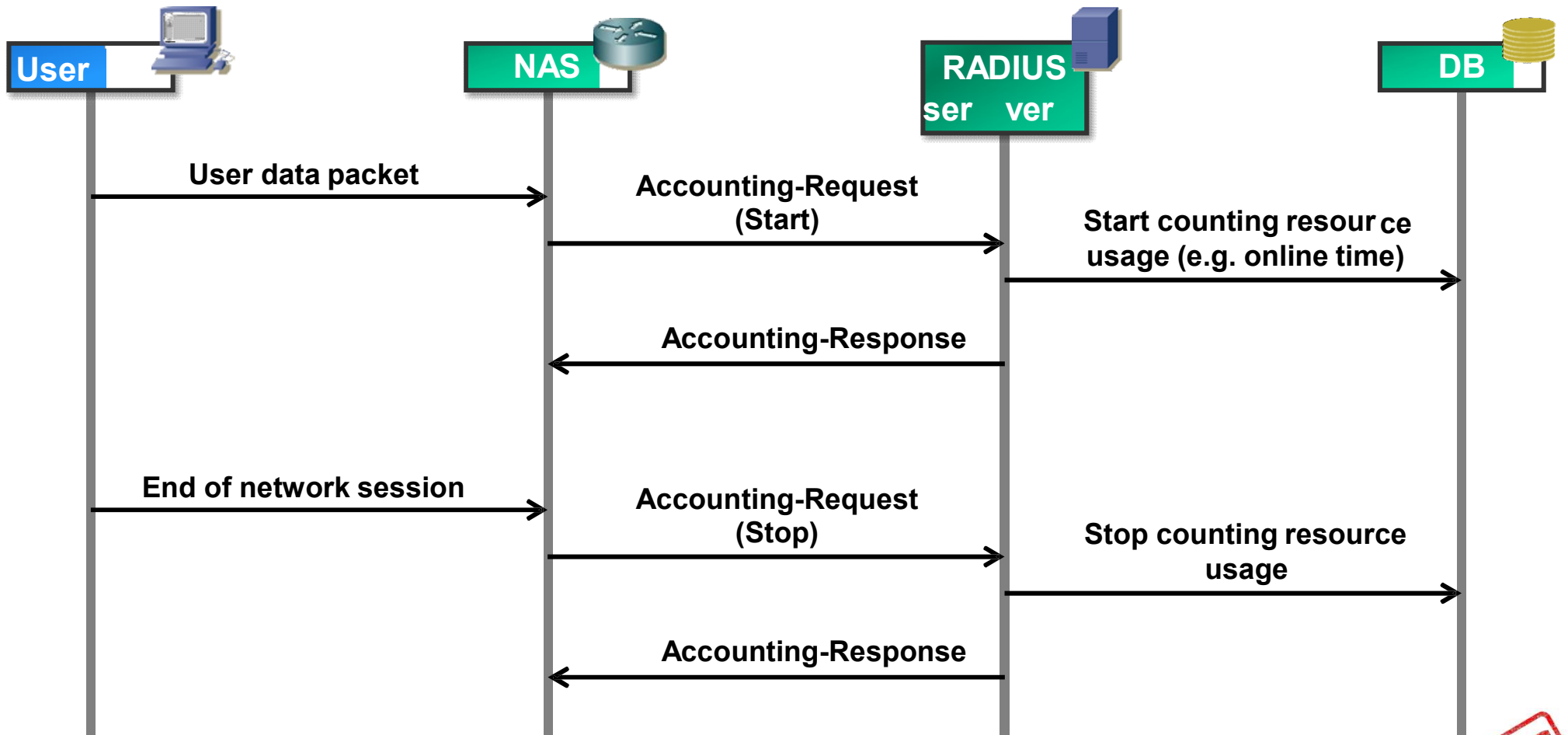

RADIUS Accounting (2)

RADIUS accounting

Accounting with RADIUS is specified in a separate RFC ([RFC2866](#)).

A set of special accounting RADIUS attributes (attribute values 40 – 59) are used to transfer accounting data between the RADIUS client (NAS) and server.

Value	Type	Description
40	Acct-Status-Type	Indicates start or stop of accounting.
41	Acct-Delay-Time	Delay between event causing accounting request and server response (used to compensate for processing delay time).
42	Acct-Input-Octets	Used by client to report number of received octets to server.
43	Acct-Output-Octets	Used by client to report number of transmitted octets to server.
44	Acct-Session-Id	Used by client to identify user session to server.
45	Acct-Authentic	Used by client to report authentication method to server, e.g. user authenticated by NAS itself, user authenticated by RADIUS or user authenticated by external protocol.
46	Acct-Session-Time	Used by client to report to server how many seconds the user session is running.
47	Acct-Input-Packets	Used by client to report number of packets received by a user.
48	Acct-Output-Packets	Used by client to report number of packets sent by a user.
49	Acct-Terminate-Cause	Used by client to report cause of service termination (e.g. error, termination upon user request, timeout).
50	Acct-Multi-Session-Id	Similar to Acct-Session-Id, but used to link multiple sessions to one for correlation in log file.
51	Acct-Link-Count	Used by client to report number of links used by user.



RADIUS Applications(1)

NAS network access (ISP):

A user dials in on a NAS server run by the Internet provider.
Prior to granting access to the Internet, the NAS authenticates the user with RADIUS.

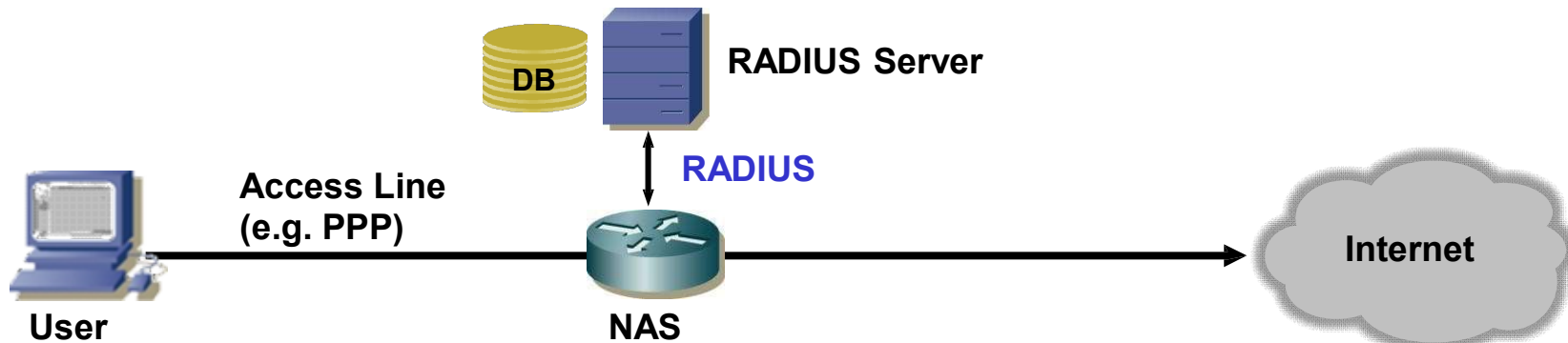

RAS Intranet access (enterprise dial-in):

This application is similar to the NAS scenario. The RAS (Remote Access Server) sits at the edge of the company network and authenticates a user prior to granting access to the network.

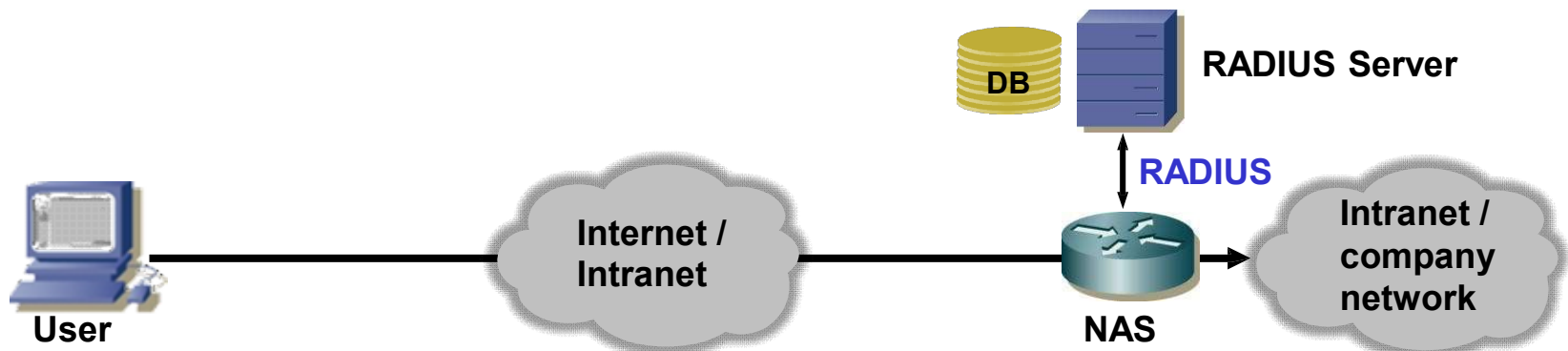

RADIUS Applications(2)

802.1X backend control for Ethernet and WLAN network access:

IEEE 802.1X is a generic protocol for authentication and authorization in IEEE 802 based networks.

The 802.1X supplicant ('the user') sends an EAPOL (Extensible Authentication Protocol Over LAN) message to the 802.1X authenticator (switch, access point).

The switch or access point enables the Ethernet or WiFi port if the backend authentication based on credentials provided via 802.1X is successful.

Using a central server for authentication (username and password storage) eases administration in large networks.

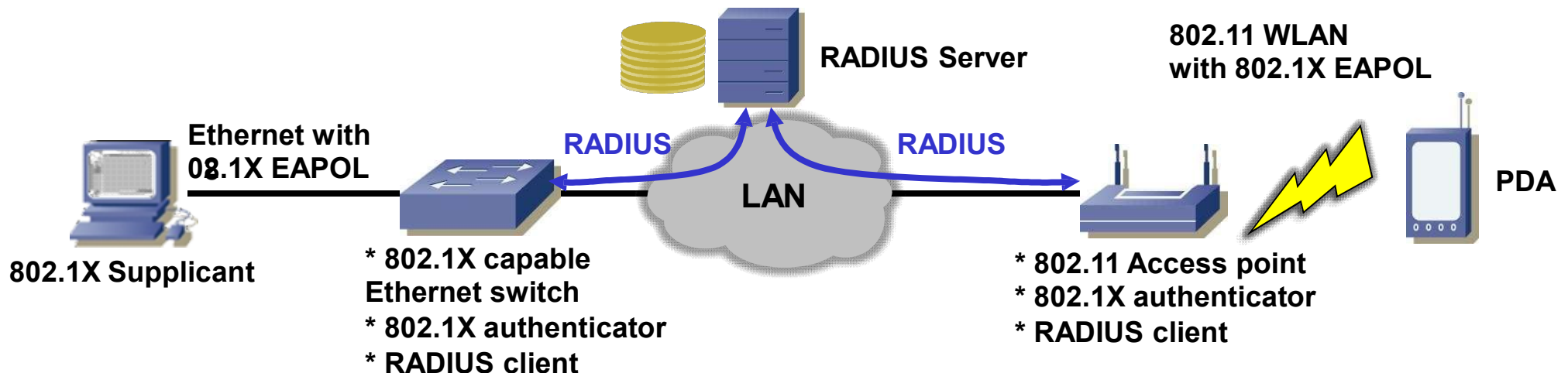

Why do we need RADIUS?

- ◆ Many services require password authentication!
- ◆ Users don't want to remember many passwords
- ◆ Easier to change password regularly or if compromised
- ◆ Easier to secure a single password database
- ◆ Enables user-password auth with 802.1x
- ◆ Alternative to TACACS for network equipment
- ◆ Used for PPP authentication in ISPs (PAP/CHAP)

RADIUS message types

- ◆ Access-Request
- ◆ Access-Challenge
- ◆ Access-Accept
- ◆ Access-Reject
- ◆ Accounting-Request
- ◆ Accounting-Response
- ◆ Status-Server (experimental)
- ◆ Status-Client (experimental)

RADIUS attributes

- ◆ Name=Value
 - ◆ User-Name
 - ◆ User-Password
 - ◆ NAS-IP-Address
 - ◆ NAS-Port
 - ◆ Service-Type
 - ◆ NAS-Identifier
 - ◆ Framed-Protocol
 - ◆ Vendor-Specific
 - ◆ Calling-Station-ID
 - ◆ Called-Station-Id

RADIUS users database (file)

- ◆ Flat text file
 - ◆ Easy to understand and edit
 - ◆ Alternatives include Kerberos, LDAP and SQL
- ◆ Each user entry has three parts:
 - ◆ Username
 - ◆ List of check items (requirements)
 - ◆ List of reply items (assignments)

RADIUS users database (file)

- ◆ Flat text file
 - ◆ Easy to understand and edit
 - ◆ Alternatives include Kerberos, LDAP and SQL
- ◆ Each user entry has three parts:
 - ◆ Username
 - ◆ List of check items (requirements)
 - ◆ List of reply items (assignments)

User entry example

Franko

Password = 'testing12'

Service-Type = Frame-User,

Framed-protocol = PPP,

Framed-IP-Address = 192.168.1.4

Framed-IP-Netmask = 255.255.255.0

- ◆ Username is Franko (case sensitive!)
- ◆ Check items (first line, all must match Access-Req):
 - ◆ password = testing12
- ◆ Reply items (indented lines):
 - ◆ Service-Type, Framed-IP-Address...



User name and check items

- ◆ Username
 - ◆ First part of each user entry
 - ◆ Up to 63 printable, non-space, ASCII characters
- ◆ Check Items
 - ◆ Listed on the first line of a user entry, after username
 - ◆ Multiple items are separated by commas
 - ◆ Entry only matches if all check items are present in the Access-Request and match
 - ◆ *Fall-Through = Yes* allows server to try other entries
- ◆ First line (user name + check items) must not exceed 255 characters.



Operators in user entries

- ◆ The “=” and “==” operators mean different things in *check items* and *reply items*!
- ◆ In *check items*:
 - ◆ Use “=” for server configuration attributes (Password, Auth-Type)
 - ◆ Sets the value if not already set (set without override)
 - ◆ Use “==” for RADIUS protocol attributes
 - ◆ True if value is present and has the same value, never sets
- ◆ In *reply items*:
 - ◆ Use “=” for RADIUS protocol attributes
 - ◆ Do not use “==”, it is never valid



The Auth-Type check item

- ◆ Used to specify where (how) to lookup the password:
 - ◆ Local (in the users file)
 - ◆ System (query the OS, /etc/shadow or PAM)
 - ◆ SecurID
- ◆ Defaults to Local
- ◆ Example:

Franko Auth-Type = Local, Password = 'test123'



Password expiration

- ◆ Disable logins after a particular date
- ◆ Use the *Expiration* check item:
Franko Password="test12", Expiration="May 12 2009"
- ◆ Date must be specified in "Mm dd yyyy" format!
- ◆ Use the *Password-Warning* check item to warn the user *before* their password expires:

VALUE	Server-Config	Password-Expiration	30
VALUE	Server-Config	Password-Warning	5



Checking the NAS IP address and port

- ◆ NAS-IP-Address check item
 - ◆ Matches a particular NAS (by IP address)
 - ◆ Will only match if the user connected to (Access-Request came from) that specific NAS.
- ◆ NAS-Port-Type check item
 - ◆ Will only match if the NAS reports that the user connected to a specify the type of port
 - ◆ Options include: Async, Sync, ISDN
- ◆ NAS-Port check item
 - ◆ Will only match if the NAS reports that the user connected to a specific port (ethernet or serial)



Reply items

- ◆ If all check items in the user entry are satisfied by the access-request, then:
- ◆ Radius server sends an Access-Accept packet to the NAS, containing the reply items
- ◆ Gives information to the NAS about the user
 - ◆ For example, which IP address to assign to them

The Service-Type reply item

- ◆ Service Type
 - ◆ Must be specified
 - ◆ Login-User → User connects via telnet, rlogin
 - ◆ Framed-User → User uses PPP or SLIP for connection
 - ◆ Outbound-User → User uses telnet for outbound connections.
- ◆ Framed-User is by far the most used now
- ◆ Framed-User requires a Framed-Protocol:

Franko Auth-Type = System

Service-Type = Framed-User

Framed-Protocol = PPP



The Framed-IP-Address reply item

- ◆ Specifies the user's IP address to the NAS
- ◆ Set to 255.255.255.255 to force the NAS to negotiate the address with the end-node (dial-in user)
- ◆ Set to 255.255.255.254, or leave out, to force the NAS to assign an IP address to the dial-in user from the assigned address pool

Franko Auth-Type = System

Service-Type = Framed-User

Framed-Protocol = PPP

Framed-IP-Address = 192.168.1.4



Netmask and Route reply items

- ◆ Use *Framed-IP-Netmask* to specify a netmask for the user's IP address
 - ◆ The default subnet mask is 255.255.255.255
- ◆ Use *Framed-Route* to add a route to NAS routing table when service to the user begins
 - ◆ Three pieces of information are required:
 - ◆ the destination IP address
 - ◆ gateway IP address
 - ◆ metric
 - ◆ For example:
 - ◆ Framed-Route = "196.200.219.0 196.200.219.4 1"

Accounting records

- ◆ FreeRADIUS writes to its Detail log file
- ◆ Typically *Start* and *Stop* accounting records

Tue May 12 14:12:14 2009

Acct-Session-Id = "25000005"

User-Name = "franko"

NAS-IP-Address = 196.200.219.2

NAS-Port = 1

NAS-Port-Type = Async

Acct-Status-Type = **Start**

Acct-Authentic = RADIUS

Service-Type = Login-User

Login-Service = Telnet

Login-IP-Host = 196.200.219.254

Acct-Delay-Time = 0

Timestamp = 838763356



Accounting attributes

- ◆ Acct-Status-Type attribute
 - ◆ indicates whether the record was sent when the connection began (Start) or when it ended (Stop)
- ◆ Acct-Session-Id attribute
 - ◆ ties the Start and Stop records together, indicating that it's the same session

What is FreeRADIUS?

- ◆ The premier open source RADIUS server
- ◆ Similar to Livingston RADIUS 2.0
- ◆ Many additional features
- ◆ Free!

Secret (digression)

- ◆ From RFC 2865:
 - ◆ The secret (password shared between the client and the RADIUS server) SHOULD be at least as large and unguessable as a well-chosen password. It is preferred that the secret be at least 16 octets. This is to ensure a sufficiently large range for the secret to provide protection against exhaustive search attacks. The secret MUST NOT be empty (length 0) since this would allow packets to be trivially forged.
- ◆ How to generate a new, secure random key:
 - ◆ `dd if=/dev/random bs=16 count=1 | base64`
 - ◆ `eAiYEcnU/nxEsp6of5DaGQ==` (for example)



What more could we do?

- ◆ Store credentials in:
 - ◆ a database (MySQL, PostgreSQL)
 - ◆ LDAP
 - ◆ Kerberos
- ◆ Integrate with network access control (802.1x)
- ◆ Generate accounting data
 - ◆ so that we could bill for timed access to resources
 - ◆ for example a wireless hotspot or a hotel network
- ◆ Generate reports from accounting data

Bibliography

- ◆ FreeRADIUS website
 - ◆ <http://www.freeradius.org>
- ◆ OpenLDAP
 - ◆ <http://www.openldap.org/>
- ◆ Other resource
 - ◆ http://www.indigoo.com/dox/itdp/09_Access/AAA_RA_DIUS.pdf