

# Internet Protocol Addressing



Routing and Switching  
tzNOG

# Purpose of an IP address

---

- Unique Identification of:
  - Source
    - How would the recipient know where the message came from?
    - How would you know who hacked into your network (network/data security)
  - Destination
    - How would you send data to other network
- Network Independent Format
  - IP over anything

# Purpose of an IP Address

---

Identifies a machine's connection to a network

- Uniquely assigned in a hierarchical format
  - IANA (Internet Assigned Number Authority)
  - IANA to RIRs (AfrinIC, ARIN, RIPE NCC, APNIC, LACNIC)
  - RIR to ISPs and large organisations
  - ISP or company IT department to end users
- IPv4 uses unique 32-bit addresses
- IPv6 uses unique 128-bit addresses

# Basic Structure of an IPv4 Address

---

- 32 bit number (4 octet number):  
(e.g. 133.27.162.125)
- Decimal Representation:

133	27	162	125
-----	----	-----	-----

- Binary Representation:

10000101	00011011	10100010	01111101
----------	----------	----------	----------

- Hexadecimal Representation:

85	1B	A2	7D
----	----	----	----

# Address Exercise

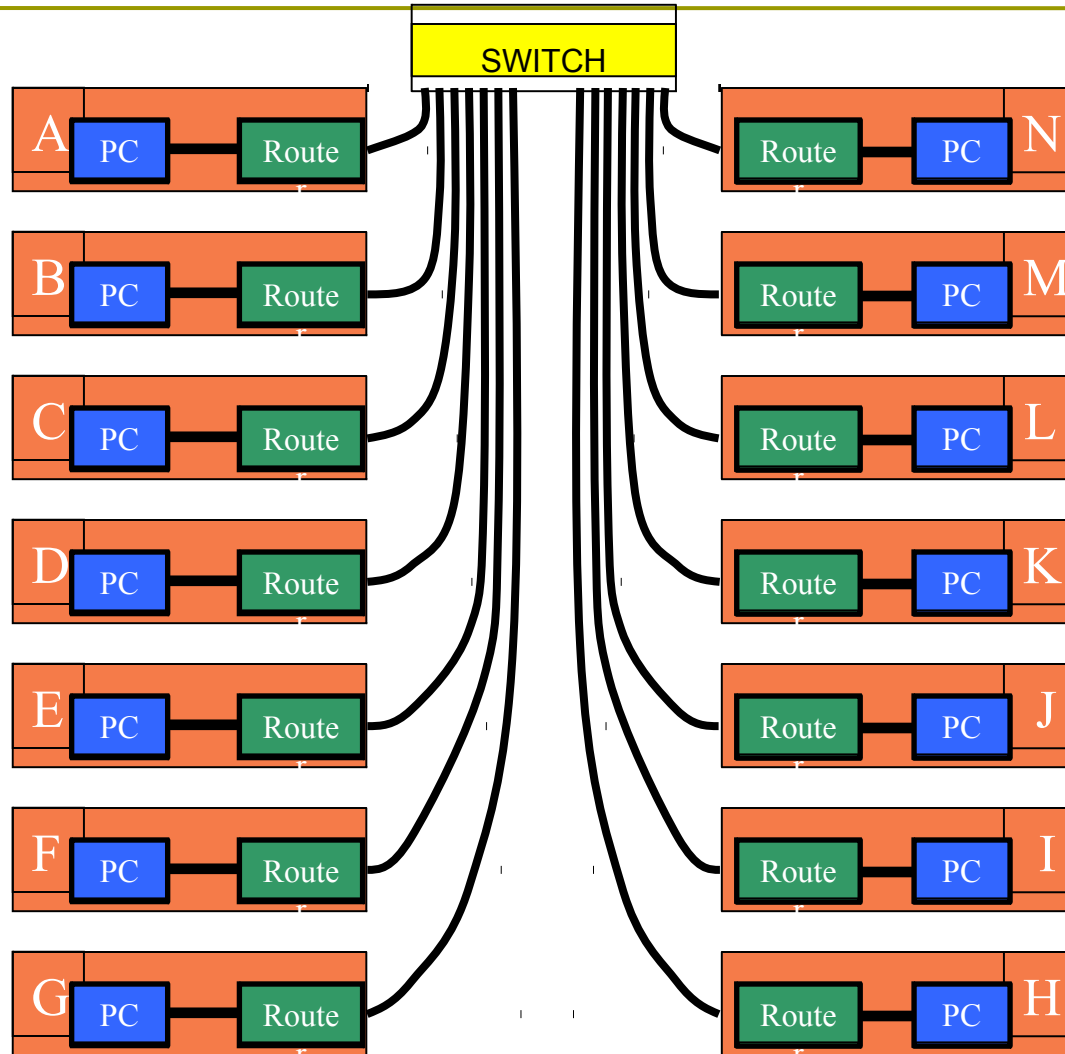

# Address Exercise

---

- Construct an IP address for your router's connection to the backbone network.
- 197.4.12.x
- x = 1 for row A, 2 for row B, etc.
- Write it in decimal form as well as binary form.

# Addressing in Internetworks

---

- The problem we have
  - More than one physical network
  - Different Locations
  - Larger number of hosts/computer systems
  - Need a way of numbering them all
- We use a structured numbering system
  - Hosts that are connected to the same physical network may have “similar” IP addresses

# Network part and Host part

---

- Remember IPv4 address is 32 bits
- Divide it into a “network part” and “host part”
  - “network part” of the address identifies which network in the internetwork (e.g. the Internet)
  - “host part” identifies host on that network
  - Hosts or routers connected to the same link-layer network will have IP addresses with the same network part, but different host part.
  - Host part contains enough bits to address all hosts on that subnet; e.g. 8 bits allows 256 addresses



# Dividing an address

---

- Hierarchical Division in IP Address:
  - Network Part (or Prefix) – high order bits (left)
    - describes which physical network
  - Host Part – low order bits (right)
    - describes which host on that network

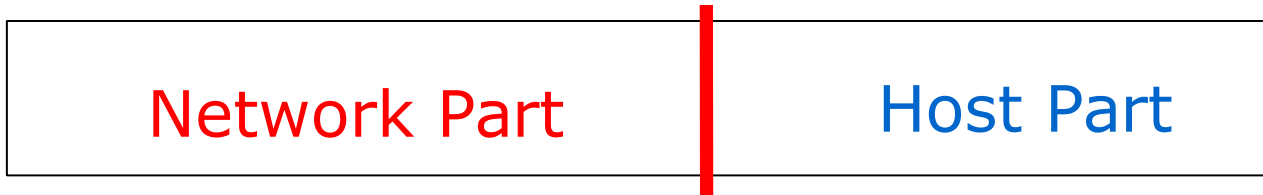

- Boundary can be anywhere
  - Boundaries are chosen according to number of hosts required

# Network Masks

---

- “Network Masks” help define which bits describe the Network Part and which for the Host Part
- Different Representations:
  - decimal dot notation: 255.255.224.0
  - binary: 11111111 11111111 11100000 00000000
  - hexadecimal: 0xFFFFE000
  - number of network bits: /19
    - count the 1's in the binary representation
- Above examples all mean the same: 19 bits for the Network Part and 13 bits for the Host Part

# Example Prefixes

- 137.158.128.0/17 (netmask 255.255.128.0)

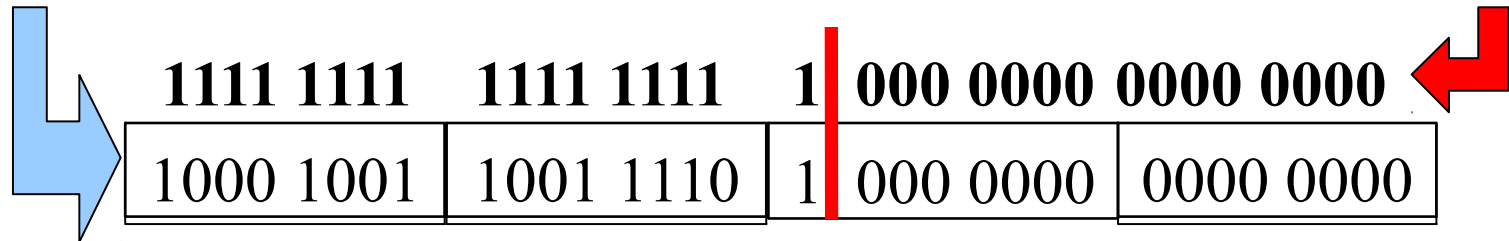

- 198.134.0.0/16 (netmask 255.255.0.0)

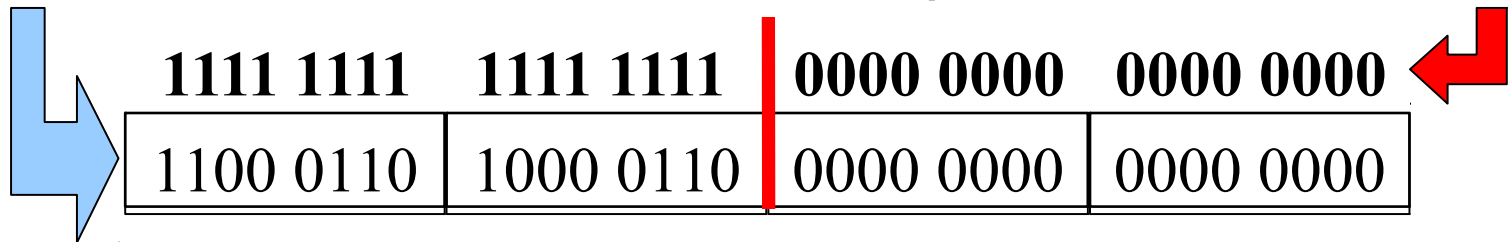

- 205.37.193.128/26 (netmask 255.255.255.192)

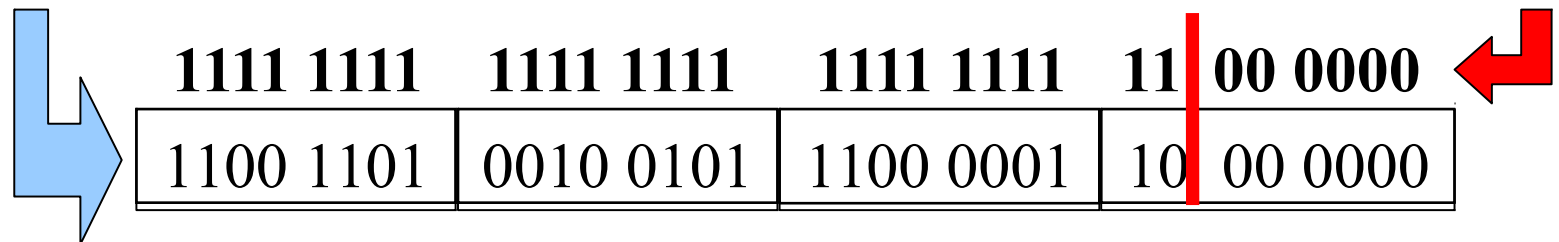

# Special Addresses

---

- All 0's in host part: Represents Network
  - e.g. 193.0.5.0/24
  - e.g. 138.37.64.0/18
- All 1's in host part: Broadcast
  - e.g. 193.0.0.255 (prefix 193.0.0.0/24)
  - e.g. 138.37.127.255 (prefix 138.37.64.0/18)
- 127.0.0.0/8: Loopback address (127.0.0.1)
- 0.0.0.0: For various special purposes

# Ancient History:

---

- A classful network naturally “implied” a prefix-length or netmask:
  - Class A: prefix length /8 (netmask 255.0.0.0)
  - Class B: prefix length /16 (netmask 255.255.0.0)
  - Class C: prefix length /24 (netmask 255.255.255.0)
- Modern (classless) routed networks rather have explicit prefix-lengths or netmasks.
  - So ideally you can't just look at an IP address and tell what its prefix-length or netmask should be.
  - Protocol configurations in this case also need explicit netmask or prefix length.

# Post-1994 era of classless addressing

---

- Class A, Class B, Class C terminology and restrictions are now of historical interest only
  - Obsolete since 1994
- Internet routing and address management today is classless
- **CIDR = Classless Inter-Domain Routing**
  - Routing does not assume that former class A, B, C addresses imply prefix lengths of /8, /16, /24
- **VLSM = Variable-Length Subnet Masks**
  - Routing does not assume that all subnets are the same size

# Classless addressing example

---

- An ISP gets a large block of addresses
  - e.g., a /16 prefix, or 65536 separate addresses
- Assign smaller blocks to customers
  - e.g., a /24 prefix (256 addresses) to one customer, and a /28 prefix (16 addresses) to another customer (and some space left over for other customers)
- An organisation that gets a /24 prefix from their ISP divides it into smaller blocks
  - e.g. a /27 prefix (32 addresses) for one department, and a /28 prefix (16 addresses) for another department (and some space left over for other internal networks)

# Classless addressing exercise

---

- Consider the address block 133.27.162.0/24
- Allocate 5 separate /28 blocks, one /27 block, and one /30 block
- What are the IP addresses of each block allocated above?
  - In prefix length notation
  - Netmasks in decimal
  - IP address ranges
- What blocks are still available (not yet allocated)?
- How big is the largest available block?



# Configuring interfaces – *ifconfig*

---

- `ifconfig interface [address_family] address [params]`
  - interface: network interface, e.g., eth0 or bge0
  - options: up, down, netmask mask
  - address: IP address
  
- Examples:
  - `ifconfig bge0 inet 192.168.2.2; ifconfig bge1 192.168.3.1`
  - `ifconfig eth0 inet 172.16.1.1/24`
  - `ifconfig bge0 192.168.2.2 netmask 255.255.255.0`
  - `ifconfig bge0 inet6 2001:db8:bdbd::123 prefixlen 48 alias`

# IPv6 Addressing



IP Addresses Continues

# IP version 6

---

- IPv6 designed as successor to IPv4
  - Expanded address space
    - Address **length** quadrupled to 16 bytes (128 bits)
  - Header Format Simplification
    - Fixed length, optional headers are daisy-chained
  - No checksum at the IP network layer
  - No hop-by-hop fragmentation
    - Path MTU discovery
  - 64 bits aligned fields in the header
  - Authentication and Privacy Capabilities
    - IPsec is mandated
  - No more broadcast

# IPv4 and IPv6 Header Comparison

## IPv4 Header

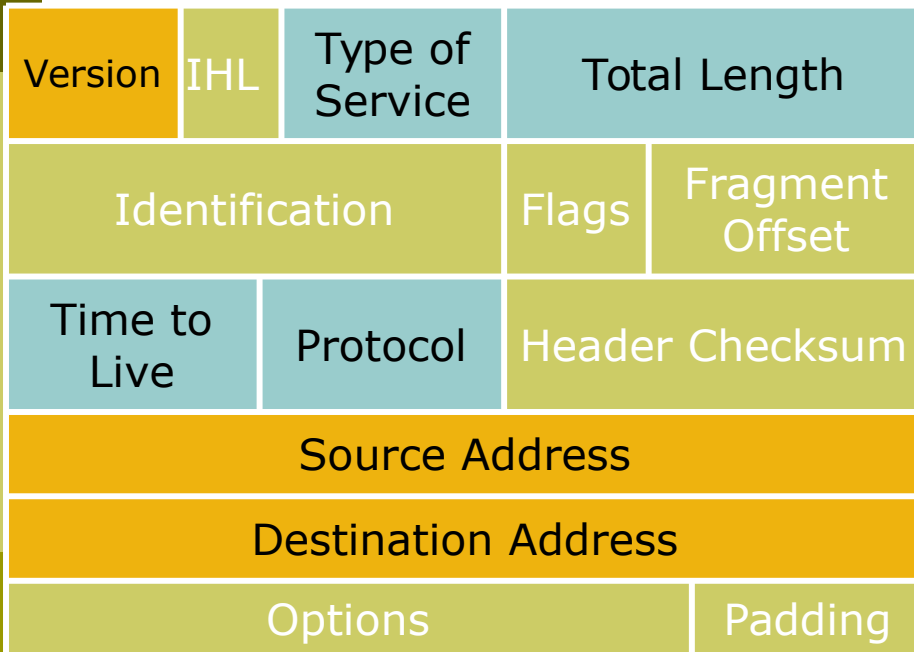

## IPv6 Header

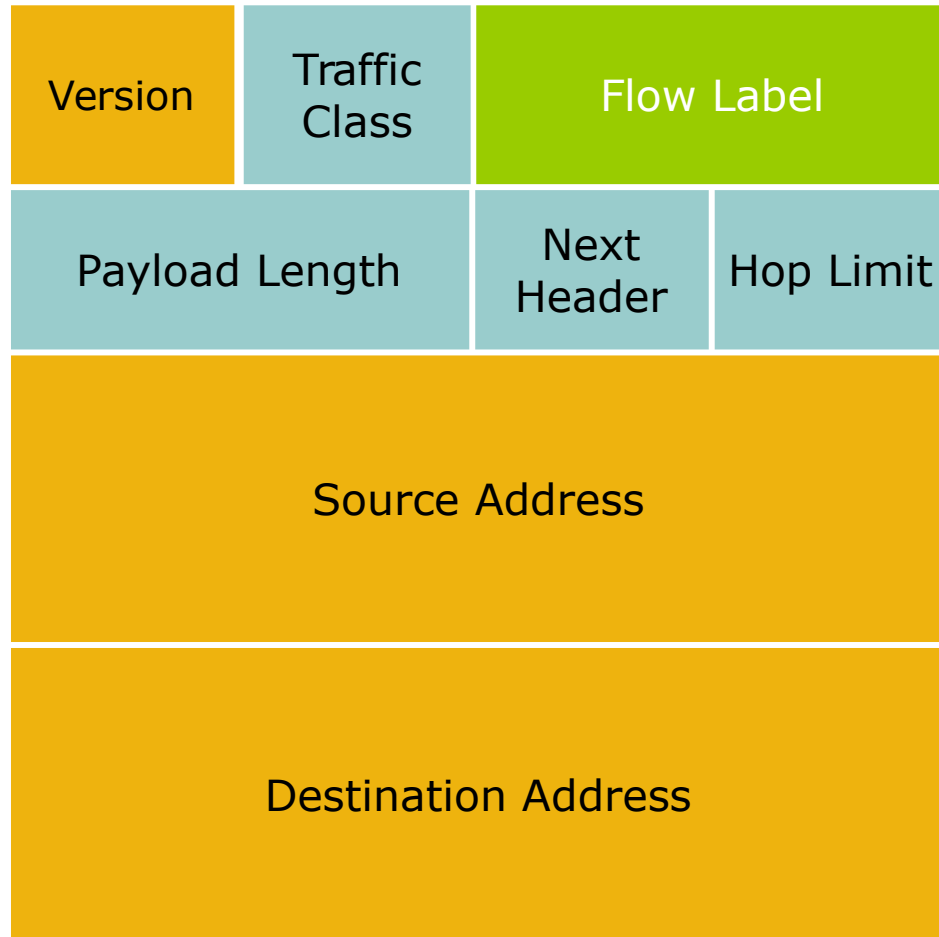

### Legend

- Field's name kept from IPv4 to IPv6
- Fields not kept in IPv6
- Name and position changed in IPv6
- New field in IPv6

# Larger Address Space

---

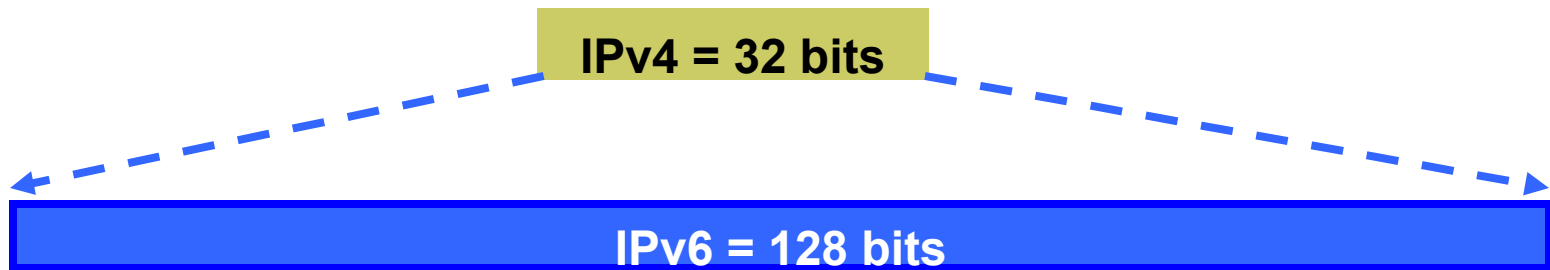

- IPv4
  - 32 bits
  - = 4,294,967,296 possible addressable devices
- IPv6
  - 128 bits: 4 times the size in bits
  - =  $3.4 \times 10^{38}$  possible addressable devices
  - = 340,282,366,920,938,463,463,374,607,431,768,211,456
  - $\sim 5 \times 10^{28}$  addresses per person on the planet

# IPv6 Address Representation

---

- 16 bit fields in case insensitive colon hexadecimal representation
  - 2031:0000:130F:0000:0000:09C0:876A:130B
- Leading zeros in a field are optional:
  - 2031:0:130F:0:0:9C0:876A:130B
- Successive fields of 0 represented as ::, but only once in an address:
  - 2031:0:130F::9C0:876A:130B      ← is ok
  - 2031::130F::9C0:876A:130B      is NOT ok (two "::")
- 0:0:0:0:0:0:0:1 → ::1      (loopback address)
- 0:0:0:0:0:0:0:0 → ::      (unspecified address)

# IPv6 Address Representation

---

- In a URL, it is enclosed in brackets (RFC3986)
  - [http://\[2001:db8:4f3a::206:ae14\]:8080/index.html](http://[2001:db8:4f3a::206:ae14]:8080/index.html)
  - Complicated for typical users
  - This is done mostly for diagnostic purposes
  - Use fully qualified domain names (FQDN) instead of this
- Prefix Representation
  - Representation of prefix is same as for IPv4 CIDR
    - Address and then prefix length, with slash separator
  - IPv4 address:
    - 198.10.0.0/16
  - IPv6 address:
    - 2001:db8:1200::/40

# IPv6 Addressing

Type	Binary	Hex
Unspecified	0000...0000	::/128
Loopback	0000...0001	::1/128
Global Unicast Address	001. . . . .	2000::/3
Link Local Unicast Address	1111 1110 10...	FE80::/10
Unique Local Unicast Address	1111 1100 ... 1111 1101 ...	FC00::/7
Multicast Address	1111 1111 ...	FF00::/8



# IPv6 Global Unicast Addresses

---

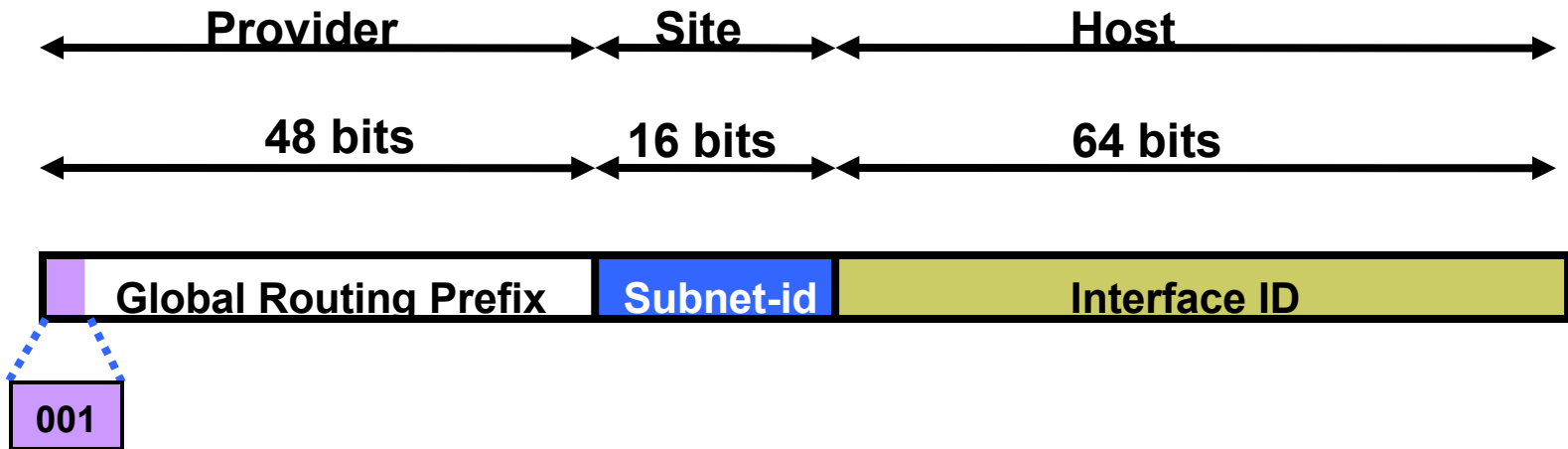

- IPv6 Global Unicast addresses are:
  - Addresses for generic use of IPv6
  - Hierarchical structure intended to simplify aggregation

# IPv6 Address Allocation

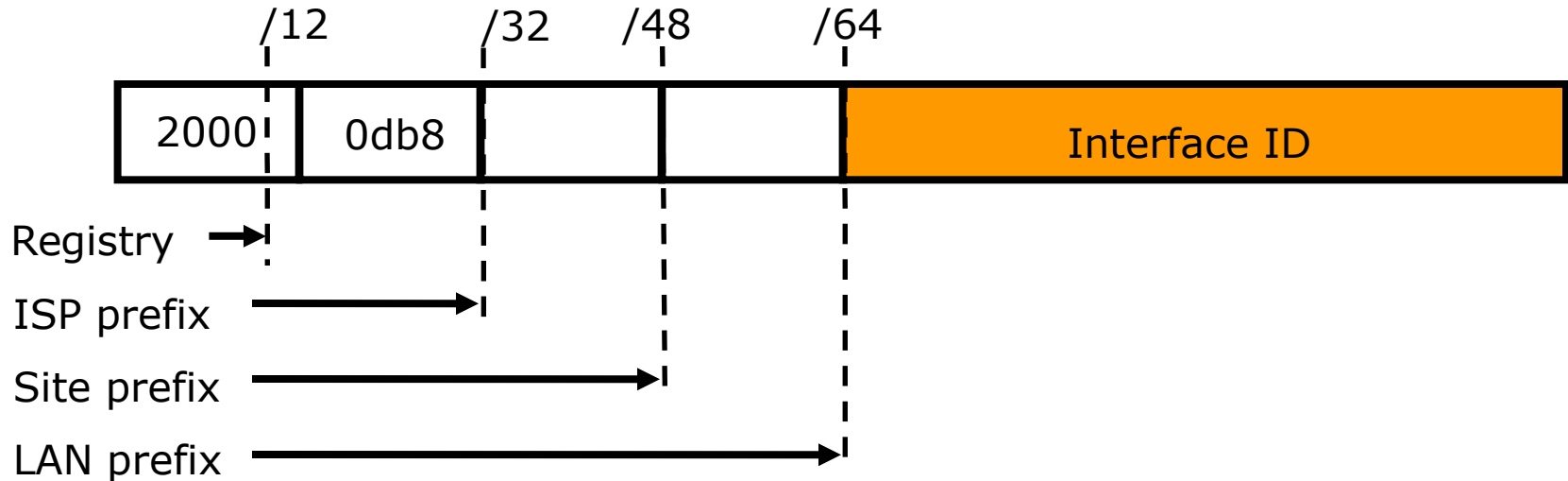

## □ The allocation process is:

- The IANA is allocating out of 2000::/3 for initial IPv6 unicast use
- Each registry gets a /12 prefix from the IANA
- Registry allocates a /32 prefix (or larger) to an IPv6 ISP
- ISPs usually allocate a /48 prefix to each end customer

# IPv6 Addressing Scope

---

- 64 bits used for the interface ID
  - Possibility of  $2^{64}$  hosts on one network LAN
  - Arrangement to accommodate MAC addresses within the IPv6 address
- 16 bits used for the end site
  - Possibility of  $2^{16}$  networks at each end-site
  - 65536 subnets

# IPV6 Subnetting

---

2001:0db8:0000:0000:0000:0000:0000:0000

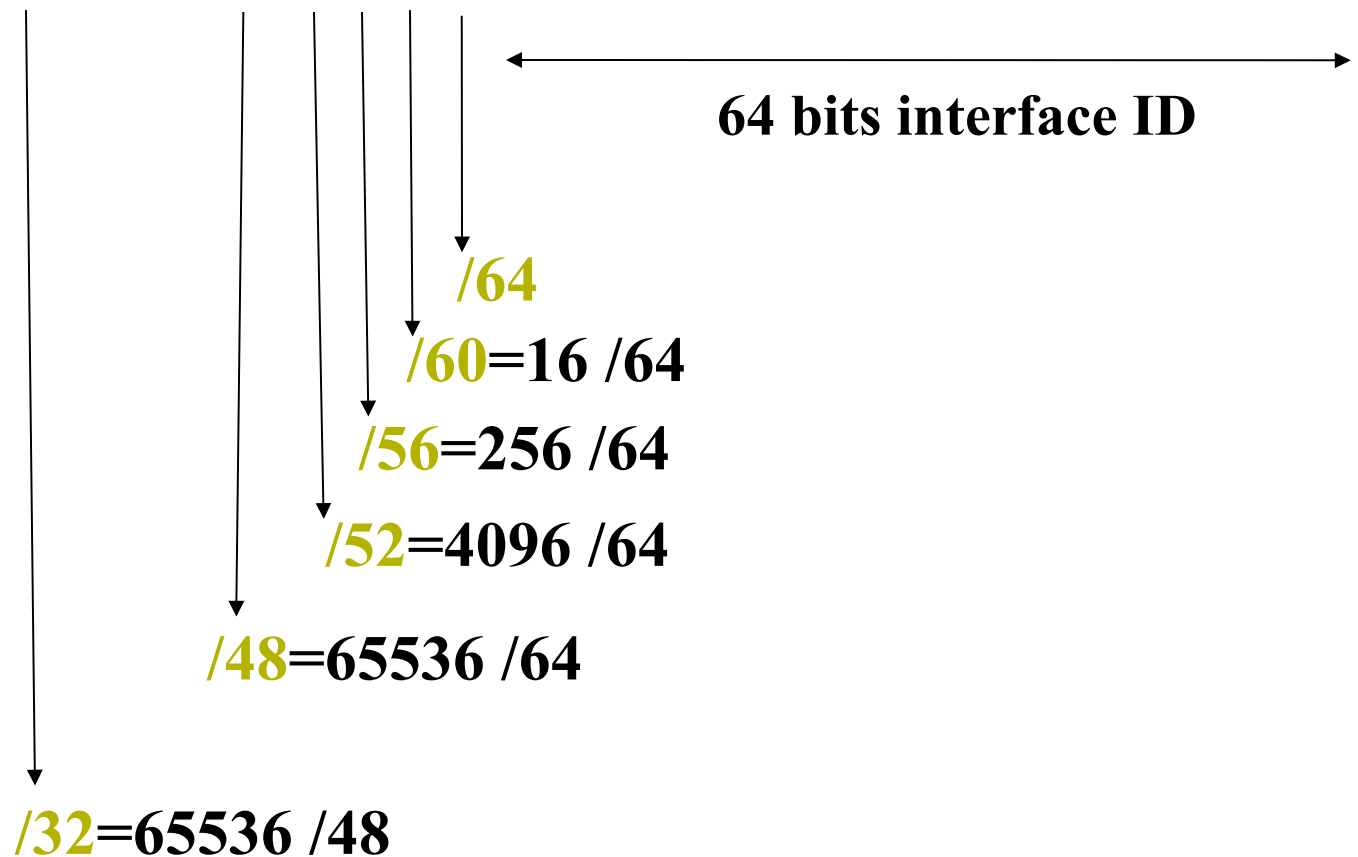

# Nibble (4 bits) Concept

---

Decimal	Binary	Hexadecimal
0	0000	0
1	0001	1
2	0010	2
3	0011	3
4	0100	4
5	0101	5
6	0110	6
7	0111	7
8	1000	8
9	1001	9
10	1010	a
11	1011	b
12	1100	c
13	1101	d
14	1110	e
15	1111	f



# Summary

---

- Vast address space
- Hexadecimal addressing
- Distinct addressing hierarchy between ISPs, end-sites, and LANs
  - ISPs are typically allocated /32s or bigger
  - End customers are typically assigned /48s
  - LANs have /64s
- Other IPv6 features discussed later





# The need for Packet Forwarding

---

- ❑ Many small networks can be interconnected to make a larger internetwork
- ❑ A device on one network cannot send a packet directly to a device on another network
- ❑ The packet has to be forwarded from one network to another, through intermediate nodes, until it reaches its destination
- ❑ The intermediate nodes are called “routers”

# An IP Router

---

- ❑ A device with more than one link-layer interface (breaks broadcast domains)
- ❑ Different IP addresses (from different subnets) on different interfaces
- ❑ Receives packets on one interface, and forwards them (usually out of another interface) to get them one hop closer to their destination
- ❑ Maintains forwarding tables and routing information base

# IP router - action for each packet

---

- ❑ Packet is received on one interface (ingress)
- ❑ Checks whether the destination address is the router itself – if so, pass it to higher TCP/IP stack layers
- ❑ Decrement TTL (time to live) and discard packet if it reaches zero (0). TTL value is a single octet and maximum is 255.
- ❑ Look up the destination IP address in the forwarding table.
- ❑ Destination could be on a directly attached link, or through another directly connected or remote router.

# Forwarding vs. Routing

---

- Forwarding: moving packets between ingress and egress interfaces
  - Depends on the forwarding table
  - Information is in the packet
- Routing: process of building routing maps and giving directions
  - One or more routing protocols
  - Procedures (algorithms) to convert routing info to forwarding table.
- (Much more later ...)

# Forwarding is hop by hop

---

- Each router makes an independent decision, based on its own forwarding table
- Different routers have different forwarding tables and make different decisions
- Routers talk routing protocols to each other, to help update routing information and forwarding tables

# Hop by Hop Forwarding

---

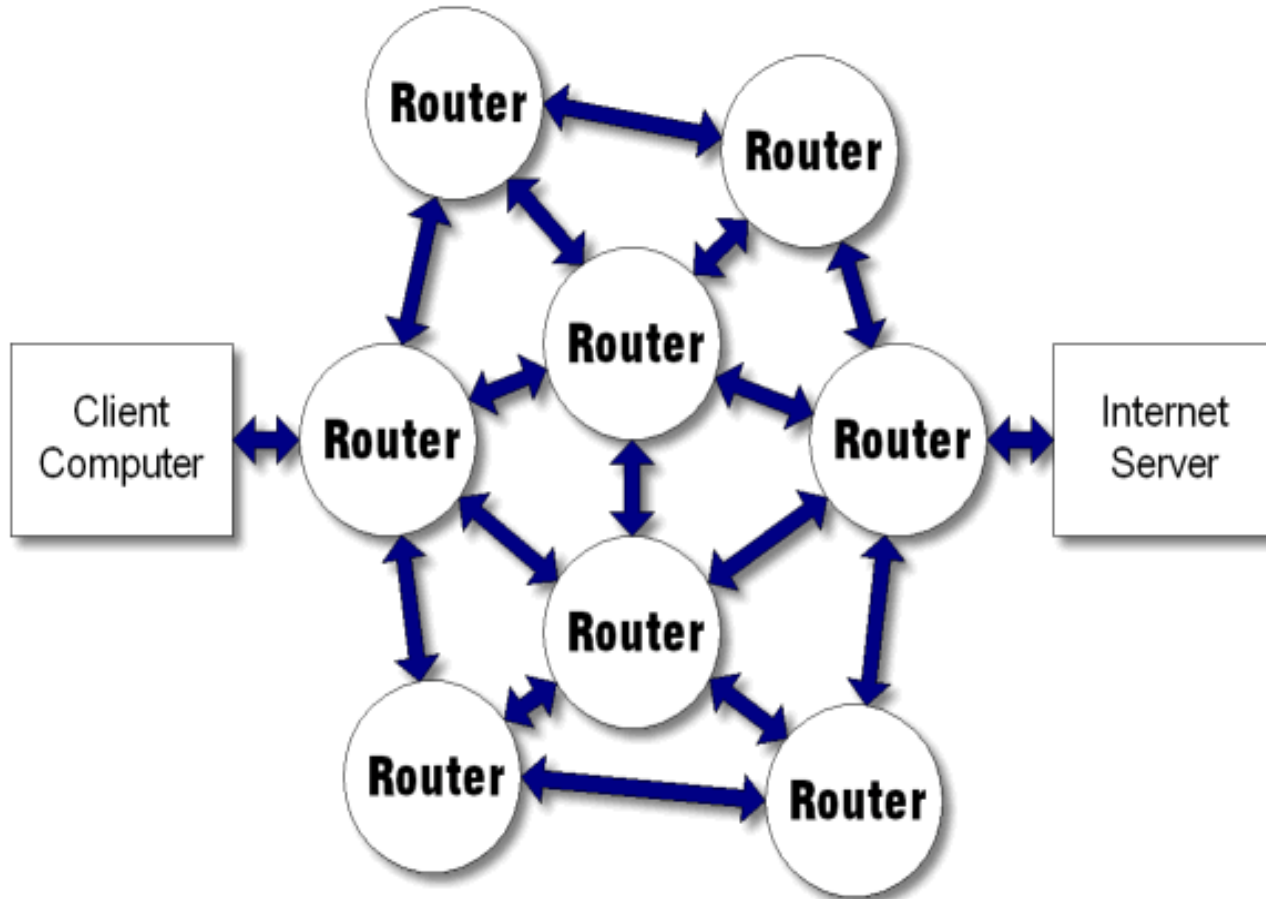

# Router Functions

---

- ❑ Determine optimum routing paths through a network
  - Lowest delay means shortest path
  - Highest reliability
- ❑ Move packets through the network
  - Determine and determine destination address in packet
  - Makes a decision on which port to forward the packet through
  - Decision is based on the Routing Table
- ❑ Interconnected Routers exchange routing tables in order to maintain a clear picture/map of the network
- ❑ In a large network, the routing table updates can consume a lot of resource (cpu, memory, bandwidth)
  - a protocol for route updates is required

# Forwarding table structure

---

- Not every IP address on the Internet is listed otherwise the routing/forwarding table would be huge.
- Instead, the forwarding table contains ip prefixes (networks or subnetwork)
  - "If the first /n bits in the routing table matches this entry, send the datagram that way"
  - If more than one prefix matches, the longest prefix wins (more specific routes)
- 0.0.0.0/0 is "default route" - matches anything, but only if no other prefix matches.



# ARP



Continuation

# Encapsulation Reminder

---

- Lower layers add headers (and sometimes trailers) to data from higher layers

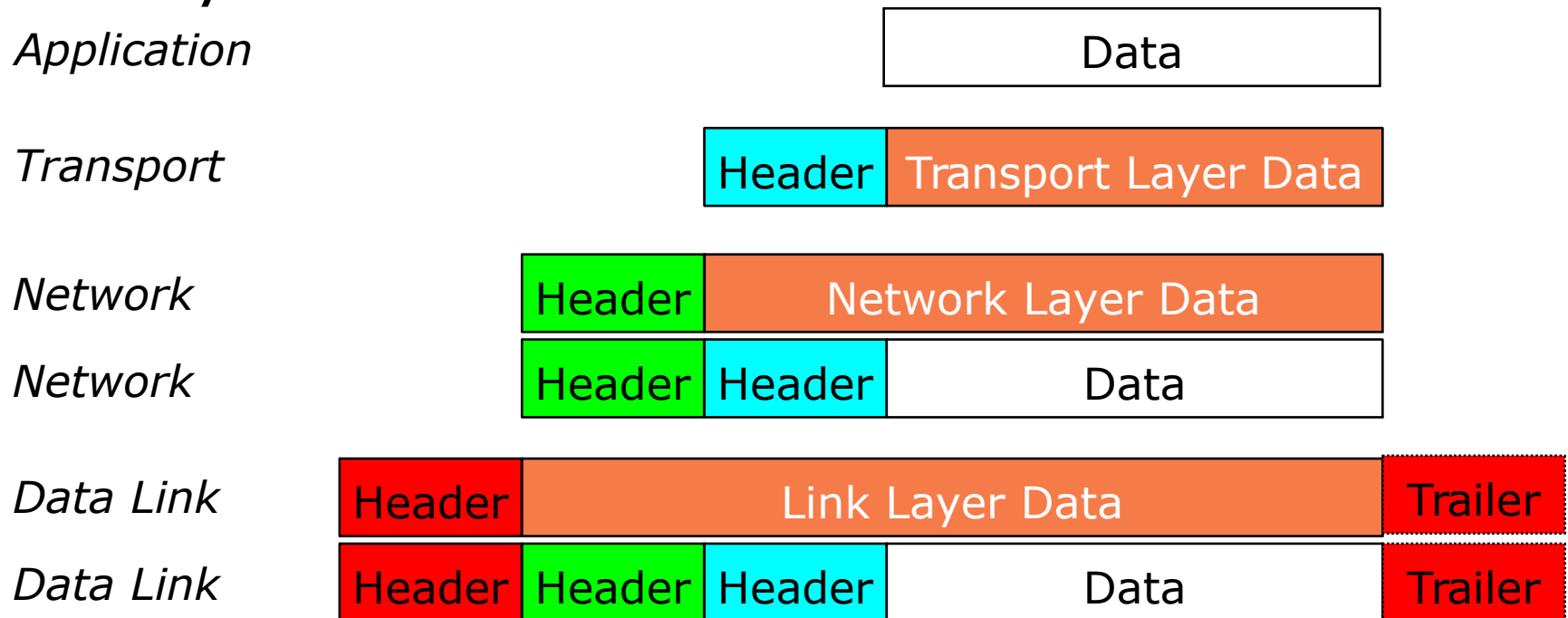

# Ethernet Essentials

---

- ❑ Ethernet is a broadcast medium
- ❑ Structure of Ethernet frame:

Preamble	Dest	Source	Length	Type	Data	CRC
----------	------	--------	--------	------	------	-----

- ❑ Entire IP packet makes data part of Ethernet frame
- ❑ Delivery mechanism (CSMA/CD)
  - back off and try again when collision is detected

# Ethernet/IP Address Resolution

---

- Internet Address
  - Unique worldwide (excepting private nets)
  - Independent of Physical Network technology
- Ethernet Address
  - Unique worldwide (excepting errors)
  - Ethernet Only
- Need to map from higher layer to lower (i.e. IP to Ethernet, using ARP)

# Address Resolution Protocol

---

- ARP is only used in IPv4
  - ND (Neighbor Discovery) replaces ARP in IPv6
- Check ARP cache for matching IP address
- If not found, broadcast packet with IP address to every host on Ethernet
- “Owner” of the IP address responds
- Response cached in ARP table for future use
- Old cache entries removed by timeout

# ARP Procedure

---

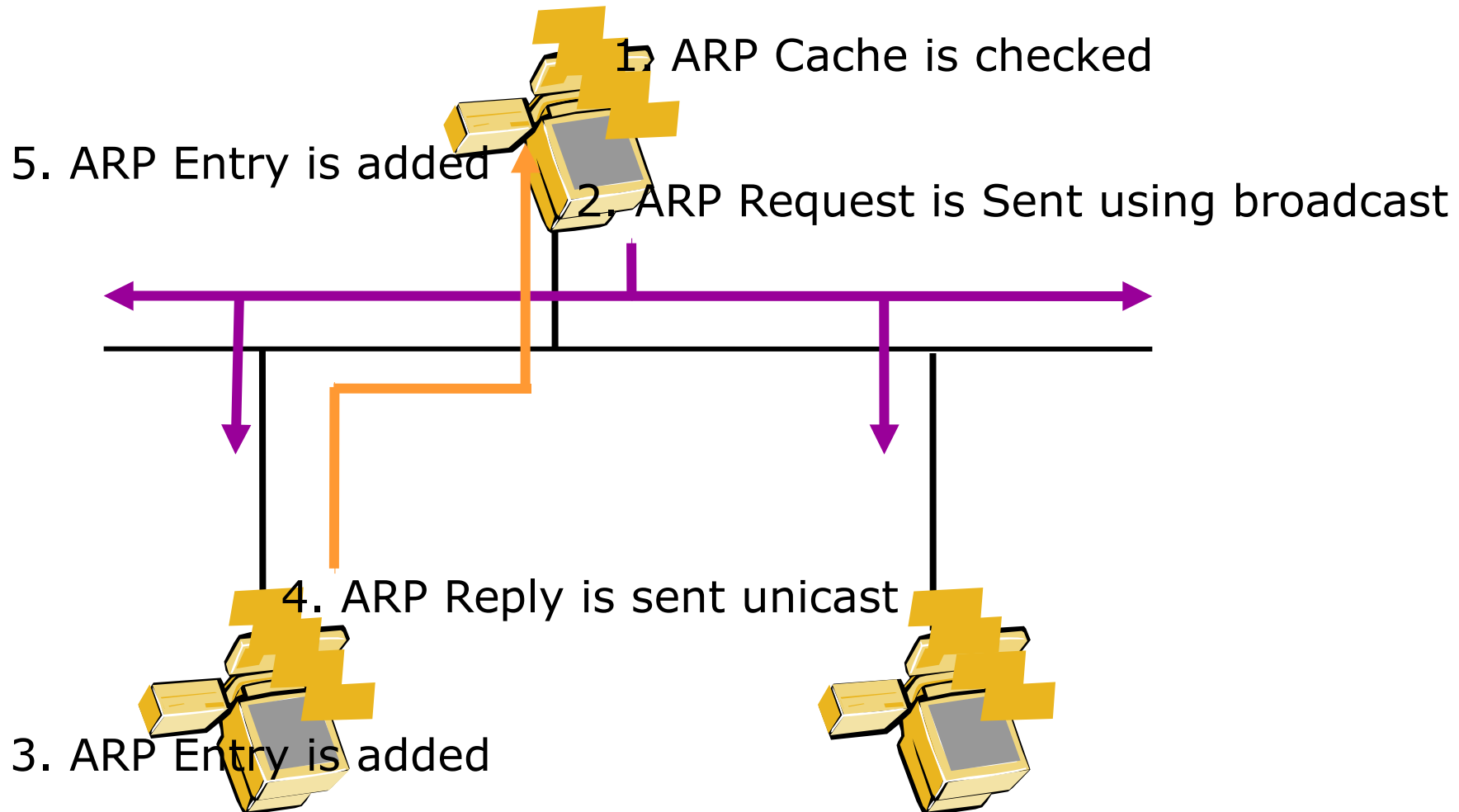

# ARP Table

---

IP address	Interface	Hardware address	Age (secs)
192.168.0.2	Gi0/1	08-00-20-08-70-54	3
192.168.0.6 5	Gi0/1	05-02-20-08-88-33	120
192.168.1.3 4	Gi0/2	07-01-20-08-73-22	43

# Types of ARP Messages

---

- ARP request
  - Who is IP addr X.X.X.X tell IP addr Y.Y.Y.Y
- ARP reply
  - IP addr X.X.X.X is Ethernet Address  
hh:hh:hh:hh:hh:hh
  - An ARP announcement is not intended to solicit a reply; instead it updates any cached entries in the ARP tables of other hosts that receive the packet.



# Thank you

---

Any questions?